

Tools

Philips Screwdriver



Allen Key (supplied)



Check List

Familiarise yourself with the contents



Check there is nothing missing



Check you have all the tools required



Make room to assemble the product



Assembly Instructions

MAP ADULT BOOKCASE



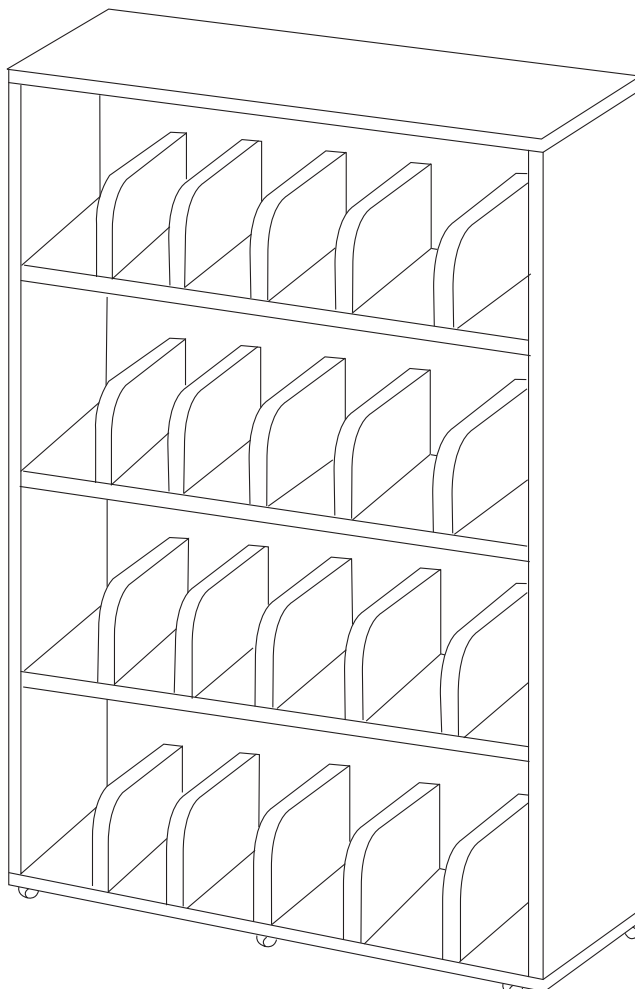

Code: MAPADLT

Before starting to assemble this unit please read the step by step assembly instructions carefully.



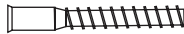





**Contact Number
0151 479 3030**

Profile Education

Components		Quantity
Confirmat Screws		76
1/2" x 8 Roundhead Screw		24
Castor lockable		3
Castor freewheel		3
Label holder		4
Allen Key		1
Glue		1

IMPORTANT Apply a small amount of glue
in to dowel holes before dowels are inserted

Contact Number
0151 479 3030

Panels	Quantity	Size (mm)
	2	1411x338mm
	1	1170x340mm
	1	1170x350mm
	2	1139x336mm
	1	1139x336mm
	4	1139x342mm
	20	280x155mm

Optional wall fixings are supplied with this product

**IMPORTANT Panels lettered for identification if spare part is required.
Please also state colour.**

**Contact Number
0151 479 3030**

Step 1

Secure (6) castors to Bottom C using (24) 1/2" x 8 screws into 'Pop Marks' - lockable to front or rear.

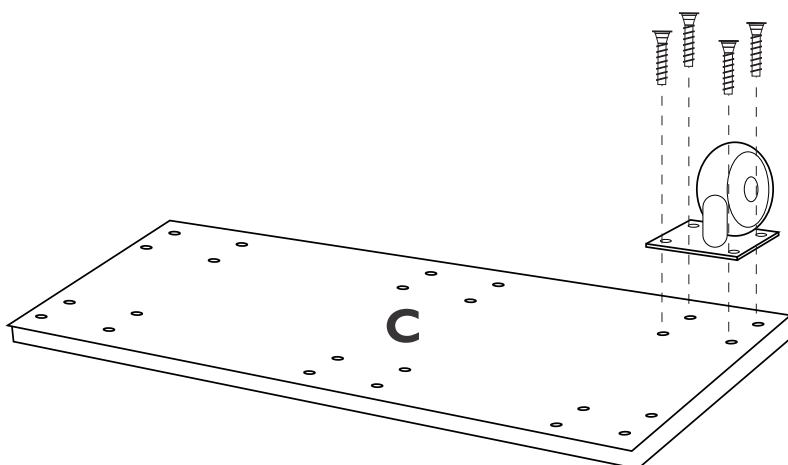

Step 2

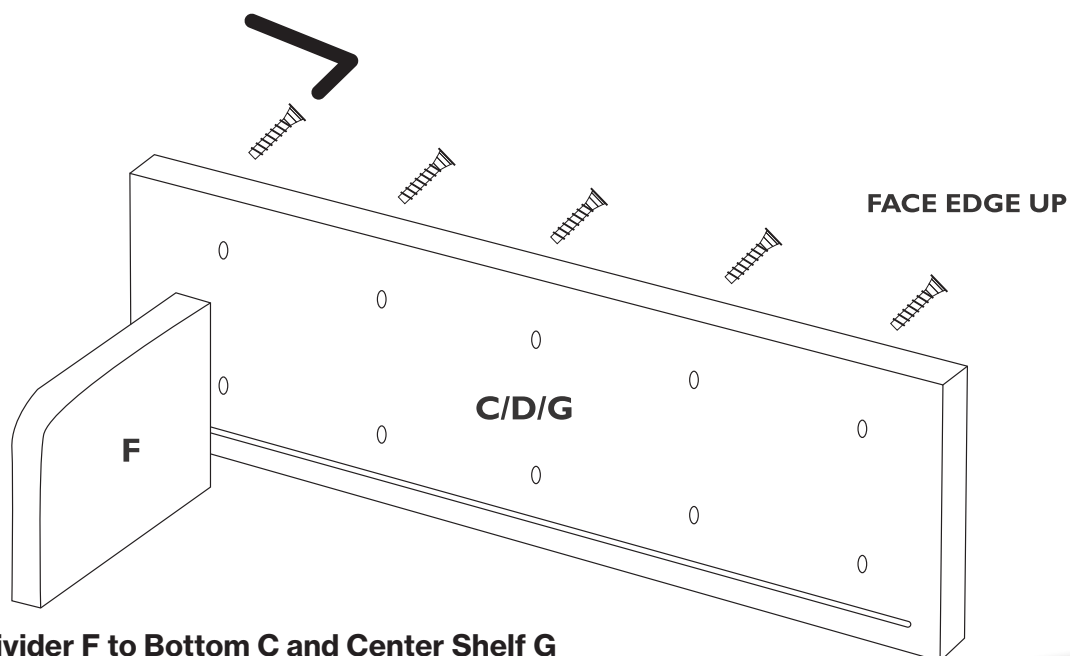

Secure (5) Divider F to Bottom C and Center Shelf G using (10) Confirmat Screws. Repeat for Shelves D.

NB. 41mm SPACE IN BOTTOM C AND CENTRE SHELF G.

Contact Number
0151 479 3030

Step 3

DO NOT TIGHTEN SCREWS

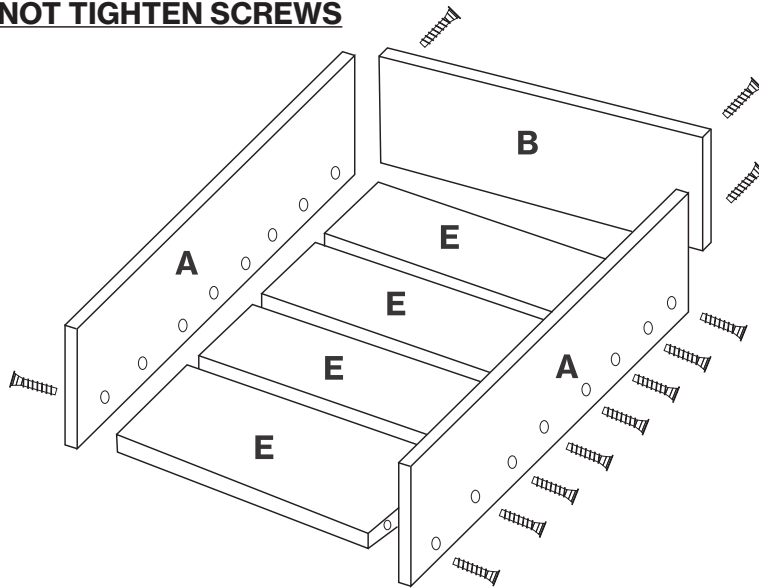

1. Secure Top B to Ends A using (4) Confirmat Screws.

2. Secure (4) Backs E to Ends A using (16) Confirmat Screws.

Step 4

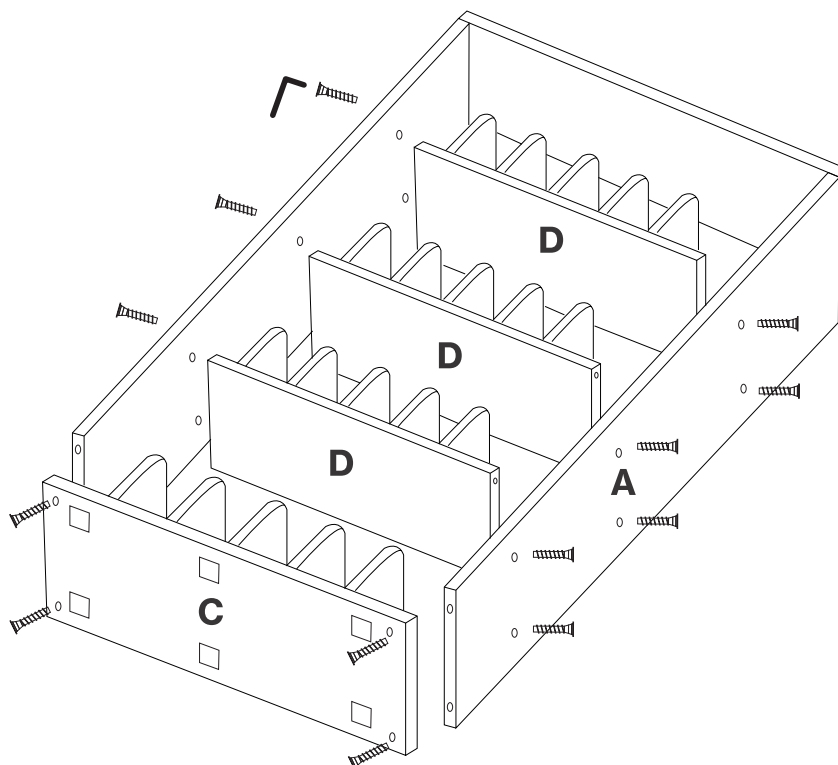

1. Secure Shelves D to Ends A using (12) Confirmat Screws.

2. Secure Bottom C to Ends A using (4) Confirmat Screws. Tighten ALL screws.

3. Peel off backing paper and stick Label Holder (4) to Shelf and Bottom Front Edges.

Optional wall fixings are supplied with this product.

YOUR UNIT IS NOW COMPLETE